

ARYAN SCHOOL OF ENGINEERING & TECHNOLOGY

BARAKUDA, PANCHAGAON, BHUBANESWAR, KHORDHA-752050



LECTURE NOTE

SUBJECT NAME- MINE GEOLOGY -II

BRANCH – MINING ENGINEERING

SEMESTER – 6TH SEM

ACADEMIC SESSION - 2022-23

PREPARED BY – DEBASISH PRADHAN

GEOLOGY

Definition:-

The science which deals with the physical structure and substance of the earth, their history, and the processes which act on them.

The geological features of a district.

The geological features of a planetary body.

The importance of geology in civil engineering may briefly as follows:

Geology provides a systematic knowledge of construction material, its occurrence, composition, durability and other properties. Example of such construction materials is building stones, road metal, clay, lime stones and laterite.

The knowledge of the geological work of natural agencies such as water, wind, ice and earthquakes helps in planning and carrying out major civil engineering works. For example the knowledge of erosion, transportation and deposition helps greatly in solving the expensive problems of river control, coastal and soil conservation.

Ground water is the water which occurs in the subsurface rocks. The knowledge about its quantity and depth of occurrence is required in connection with water supply, irrigation, excavation and many other civil engineering works.

The foundation problems of dams, bridges and buildings are directly concerned with the geology of the area where they are to be built. In these works drilling is commonly undertaken to explore the ground conditions. Geology helps greatly in interpreting the drilling data.

In tunneling, constructing roads, canals, docks and in determining the stability of cuts and slopes, the knowledge about the nature and structure of rocks is very necessary.

Before starting a major engineering project at a place, a detailed geological report which is accompanied by geological maps and sections, is prepared. Such a report helps in planning and constructing the projects.

Importance of Physical geology, Petrology and Structural Geology :Physical Geology:

Physical Geology uses the scientific method to explain natural aspects of the Earth - for example, how mountains form or why oil resources are concentrated in some rocks and not in others.

This chapter briefly explains how and why Earth's surface, and its interior, is constantly changing. It relates this constant change to the major geological topics of interaction of the atmosphere, water and rock.

Petrology:-

Petrology is the branch of geology that studies the origin, composition, distribution and structure of rocks.

(from the Greek language : petra- "rock" and logos- "study")

“Lithology” was once approximately synonymous with petrography, but in current usage, lithology focuses on macroscopic hand-sample or outcrop-scale description of rocks while petrography is the specialty that deals with microscopic details.

Branches:

There are three branches of petrology, corresponding to the three types of rocks:

Igneous, metamorphic, and sedimentary.

1. Igneous petrology focuses on the composition and texture of igneous rocks (rocks such as granite or basalt which have crystallized from molten rock or magma). Igneous rocks include volcanic and plutonic rocks.
2. Sedimentary petrology focuses on the composition and texture of sedimentary rocks (rocks such as sandstone, shale, or limestone which consist of pieces or particles derived from other rocks or biological or chemical deposits, and are usually bound together in a matrix of finer material)
3. Metamorphic petrology focuses on the composition and texture of metamorphic rocks (rocks such as slate, marble, gneiss,

or schist which started out as sedimentary or igneous rocks but which have undergone chemical, mineralogical or textural changes due to extremes of pressure, temperature or both).

4. Metamorphic rocks arise from the transformation of existing rock types, in a process called metamorphism, which means "change in form". The original rock (protolith) is subjected to heat (temperatures greater than 150 to 200 °C) causing profound physical and/or chemical change.

Structural geology:

Structural geology is the study of the three-dimensional distribution of rock units with respect to their deformational histories.

The primary goal of structural geology is to use measurements of present-day rock geometries to uncover information about the history of deformation (strain) in the rocks, and ultimately, to understand the stress field that resulted in the observed strain and geometries.

Weathering of Rocks:

Weathering breaks down and loosens the surface minerals of rock so they can be transported away by agents of erosion such as water, wind and ice.

There are two types of weathering: mechanical and chemical.

1. Mechanical or physical weathering involves the breakdown of rocks and soils through direct contact with atmospheric conditions, such as heat, water, ice and pressure.
2. The second classification, chemical weathering involves the direct effect of atmospheric chemicals or biologically produced chemicals also known as biological weathering in the breakdown of rocks, soils and minerals.

MINERALOGY

Introduction:

- A mineral is a naturally occurring substance that is solid and inorganic represent able by a chemical formula, and has an ordered atomic structure.

- Minerals are broadly grouped into

- a) The rock forming minerals and
- b) Ore-forming minerals

In civil engineering practice, it is important to have knowledge of the important rock- forming types.

The ore-forming minerals are to be understood in detail by the mining, Metallurgical and Mineral Engineering professionals.

- The study of minerals is called mineralogy.
- There are over 4,900 known mineral species; over 4,660 of these have been approved by the International Mineralogical Association (IMA).
- The silicate minerals compose over 90% of the Earth's crust.
- Minerals are distinguished by various chemical and physical properties.

Formation of minerals:

- Minerals are crystalline solid substances, meaning the atoms making up a mineral are arranged in an ordered, three-dimensional, structure.
- The distances and angles between an individual atom and the neighbors it is bonded to are constant.
- The process of mineral formation is known as crystallization. In order for a mineral to crystallize, ions from the nearby environment must be brought together.
- A second process of mineral formation occurs during cooling of a melt.
- When crystallization of this type takes place in water, we call it freezing.
- Through a very similar mechanism, molten rock-forming liquids, known as magmas and lavas, cool and crystallize to form minerals and thus rocks.

Study of minerals:

- **Mineralogy** is a subject of geology specializing in the scientific study of chemistry, crystal structure, and physical (including optical) properties of minerals.
- Specific studies within mineralogy include the processes of mineral origin and formation, classification of minerals, their geographical distribution, as well as their utilization.
- As of 2004 there are over 4,000 species of minerals recognized by the IMA. Of these, perhaps 150 can be called "common," another 50 are "occasional," and the rest are "rare" to "extremely rare."

Physical properties:

- The physical characteristics of minerals include traits which are used to identify and describe mineral species. These traits include color, streak, luster, density, hardness, cleavage, fracture, tenacity, and crystal
- Color .Cleavage
- Streak .Fracture
- Luster . Tenacity
- Density . Habit
- Hardness

PETROLOGY

Definition of rock:

- In geology, **rock** is a naturally occurring solid aggregate of one or more minerals or mineraloids.
- For example, the common rock granite is a combination of the quartz, feldspar and biotite minerals. The Earth's outer solid layer, the lithosphere, is made of rock.
- Rocks have been used by mankind throughout history. From the Stone Age, rocks have been used for tools. The minerals and metals found in rocks have been essential to human civilization.
- Three major groups of rocks are defined: Igneous, Sedimentary, and Metamorphic. The scientific study of rocks is called **petrology**.

Crystallization:

- **Crystallization** is also a chemical solid–liquid separation technique, in which mass transfer of a solute from the liquid solution to a pure solid crystalline phase occurs.
- In chemical engineering **crystallization** occurs in a crystallizer.

Dykes and sills:

- Dyke” and “sill” are geological terms used to describe an intrusion; usually a mass of igneous or volcanic rocks that forcibly entered, penetrated, and embedded into layers of another rock or land form. Dykes and sills are often associated with volcanoes though they are not exclusive to that particular land form.
- A **dike** or **dyke** in geological usage is a sheet of rock that formed in a fracture in a pre-existing rock body.
- However, when the new rock forms within and parallel to the bedding of a layers rock, it is called a **sill**.

- It is a type of tabular or sheet intrusion, that either cuts across layers in a planar wall rock structures, or into a layer or unlayered mass of rock.

Structure and texture of igneous rocks:

- The texture of igneous rocks depends on the composition of the magma and the conditions surrounding the magma's cooling.
- The textures are different in intrusive, vein, and extrusive rocks. Intrusive rocks are characterized by a holocrystalline texture, in which all the rock material is crystallized.
- Also depends on the shape of the crystals of the component minerals.

Structure and texture of Sedimentary rocks:

- The relationship between rock structure and texture and rock genesis is more pronounced in sedimentary rocks than in igneous rocks.
- Clastic rocks consist of detrital (clastic) grains of various sizes and shapes.
- The grains, which can be angular, subrounded, or rounded, sometimes lie freely without attachment.
- The structure of clastic rock, which depends on the mutual arrangement of the grains, can be random, laminar, or fluidal. With a random structure, the particles do not have an ordered arrangement.

Texture and structure of metamorphic rocks:

- The structures and textures of metamorphic rocks arise during the recrystallization in the solid state of primary sedimentary and magmatic rocks.
- The recrystallization occurs under the action of lithostatic pressure, temperature.
- Which leads to an ordered arrangement of the mineral Grains?

GROUND WATER

DEFINITION:

- **Groundwater** (or **ground water**) is the water present beneath Earth's surface in soil pore spaces and in the fractures of rock formations.
- A unit of rock or an unconsolidated deposit is called an aquifer when it can yield a usable quantity of water.
- The depth at which soil pore spaces or fractures and voids in rock become completely saturated with water is called the water table.

USES:

- Groundwater is also often withdrawn for agricultural, municipal, and industrial use by constructing and operating extraction wells.
- The study of the distribution and movement of groundwater is hydrogeology, also called **GROUNDWATER HYDROLOGY**.
- Groundwater is often cheaper, more convenient and less vulnerable to pollution than surface water.

SPRINGS:

- A **spring** is the result of an aquifer being filled to the point that the **water** overflows onto the land surface.
- They range in size from intermittent seeps, which flow only after much rain, to huge pools flowing hundreds of millions of gallons daily.

Types of springs:

- Seepage or filtration spring. The term seep refers to springs with small flow rates in which the source water has filtered through permeable earth.
- Fracture springs, discharge from faults, joints, or fissures in the earth, in which springs have followed a natural course of voids or weaknesses in the bedrock.

CONE OF DEPRESSION:

- A **cone of depression** occurs in an aquifer when groundwater is pumped from a well. In an unconfined aquifer (water table), this is an actual depression of the water levels.
- In confined aquifers (artesian), the cone of depression is a reduction in the pressure head surrounding the pumped well.

DIFFERENCE:

- The size and shape (slope) of the cone of depression depends on many factors. The pumping rate in the well will affect the size of the cone.
- Also, the type of aquifer material, such as whether the aquifer is, sand, silt, fractured rock etc., also will affect how far the cone extends.
- The amount of water in storage and the thickness of the aquifer also will determine the size and shape of the cone of depression.

- As a well is pumped, the cone of depression will extend out and will continue to expand in a radial fashion until a point of equilibrium occurs.
- This usually is when the amount of water released from storage equals the rate of pumping. This also can occur when recharge to the aquifer equals the amount of water being pumped.
- 1.Confined aquifer
2.Unconfined aquifer

AQUIFERS

What is an aquifer???

- An **aquifer** is an underground layer of water-bearing permeable rock or unconsolidated materials (gravel, sand, or silt) from which groundwater can be extracted using a water well.
- The study of water flow in **aquifers** and the characterization of **aquifers** is called hydrogeology.
- What is confining layer (aquitard)?
- Geological material through which significant quantities of water can not move, located below unconfined aquifers, above and below confined aquifers. Also known as a confining bed.

Confined aquifer(artesian) :-

- Confined aquifers are those in which an impermeable dirt/rock layer exists that prevents water from seeping into the aquifer from the ground surface located directly above.

Unconfined aquifer (water table aquifer):-

- **Unconfined aquifers** are those into which water seeps from the ground surface directly above the **aquifer**.

Unconfined aquifers:

- Natural recharge of the unconfined aquifers is mainly due to the downward seepage (or percolation) through the unsaturated zone of the excess water over passing the field capacity of the soil. Recharge can also occur through upward seepage (leakage) from underlying aquifers.

Confined aquifers:

- A regional confined aquifer is directly recharged by precipitation in the area where the aquifer crops out, having the same characteristics as an unconfined aquifer.

INFILTRATION GALLERIES:

- Infiltration galleries is a conduit,
- Built in permeable earth, for collecting ground water.
- We have seen earlier that ground water travels towards lakes, rivers or streams. This water which is travelling can be intercepted by digging a trench or by constructing a tunnel with holes on sides at right angle to the direction of flow.
- These underground tunnel used for tapping underground water near rivers, lakes or streams are called “INFILTRATION GALLERIES”.
- These are also known as Horizontal walls.

Example:-

- Infiltration galleries can be used to collect sub-surface flow from rivers. Water is taken to a collective well, or sump, and then pumped to a storage tank.
- Infiltration galleries vary in size, from a few meters feeding into spring box, to many kilometers forming an integral part of urban water supply.

Construction of galleries:

- To ensure a continuous supply of water, infiltration galleries should be built in the end of dry season and should be at least one meter under the dry season water table.
- Excavate a trench to at least 1 m below the water table,
- Lay graded gravel on the base of the trench.
- Lay the pipe or drain blocks on top of the gravel. Cover the top and sides with more graded gravel.
- Cap the gravel with an impermeable layer of clay to prevent surface water entering the gallery.

STRATIGRAPHY

Stratigraphy is a branch of geology which studies rock layers (strata) and layering (stratification).

It is primarily used in the study of sedimentary and layered volcanic rocks.

Stratigraphy includes two related subfields:

1. Lithologic stratigraphy or lithostratigraphy,
2. Biologic stratigraphy or biostratigraphy.

Application of stratigraphy was by William Smith in the 1790s and early 1800s. Smith, known as the "Father of English geology".

Created the first geologic map of England and first recognized the significance of strata or rock layering and the importance of fossil markers for correlating strata.

1) Lithostratigraphy:

Lithostratigraphy, or lithologic stratigraphy, provides the most obvious visible layering. It deals with the physical contrasts in lithology, or rock type. Such layers can occur both vertically— in layering or bedding of varying rock types.

Lithology:

The **lithology** of a rock unit is a description of its physical characteristics visible at outcrop, in hand or core samples or with low magnification microscopy, such as colour, texture, grain size, or composition.

2) Biostratigraphy:

Biostratigraphy is the branch of stratigraphy which focuses on correlating and assigning relative ages of rock strata by using the fossil assemblages contained within them.

Biologic stratigraphy was based on William Smith's principle of faunal succession, which predated, and was one of the first and most powerful lines of evidence for, biological evolution.

Out crop:

- An **outcrop** or **rocky outcrop** is a visible exposure of bedrock or ancient superficial deposits on the surface of the Earth.
- Outcrops do not cover everywhere on the surface of the earth, these are mostly covered with a thick and thin layer called alluvium or most common language as soil.
- However, in places where the overlying cover is removed through erosion or tectonic uplift, the rock may be exposed, or *crop out*.
- In fact in some areas the soil may spread over for thousands of square km and the bed block may not be visible anywhere.
- As in the mountains and sub- mountains tracts, exposure of rocks may be easily seen forming sides of valley or caps of hills.
- Hence outcrop is simply defined as “An exposure of solid rock on the surface of the rock”.

Strike :

- Strike is a geographic direction given by the line of intersection of a horizontal plane with a bedding plane of a layer of rock.
- It is measured in field with the help of a compass.

Dip:

- It is defined as the max angle of inclination with the horizontal. It is expressed both in terms of degree of inclination and direction of inclination.
- The amount of dip is called angle of inclination, which a bedding plane makes with a horizontal plane.

True Dip:

- when the dip of the layer is measured in a direction that is essentially at right angles to the strike of the particular layer, then It is called TRUE DIP.

Apparent Dip:

- When the dip of the layer is measured in any other direction which is not a right angles to the strike direction is called APPARENT DIP.

FOLDS

DEFINITION:

- Folds are one of the most common geological structures found in rocks. When a set of horizontal layers are subjected to compressive forces, they bend either upwards or downwards.
- The bends noticed in rocks are called folds.
- Folds are described variously as wavy or arch or curvy types found in rocks.
- In terms of nature too, folds may occur as single local bends or may occur repeatedly and intricately folded according to the tectonic history of the region.

Types of FOLDS:

Based on different principles, the folds are variously classified on:

1. Symmetrical character.
2. Upward or downward bend.
3. Occurrence of plunge.
4. Bed thickness
5. Behaviour of the fold pattern.

Anticline and Syncline:

- When beds are bent upwards, the resulting fold is called Anticline. This fold is convex upwards.

- (*Anti*= Opposite, *Cline*= Inclination)
- Syncline is just opposite to anticline on its nature, when the beds are bent downwards the resulting fold is called Syncline.

Symmetrical and Asymmetrical folds:

- When the axial plane divides a fold into two equal halves in such a way that one half is the mirror image of another, then such fold is called Symmetrical fold.
- If the two halves are not mirror images, then the fold is called Asymmetrical fold. IF the compressive forces responsible for folding are not of the same magnitude, asymmetrical folds are formed.
- Open and Closed Folds
- Similar and Parallel Folds

STRUCTURAL GEOLOGY

STRATIGRAPHY:

Stratigraphy is a branch of geology which studies rock layers (strata) and layering (stratification).

It is primarily used in the study of sedimentary and layered volcanic rocks.

Stratigraphy includes two related subfields:

1. Lithologic stratigraphy or lithostratigraphy,
2. Biologic stratigraphy or biostratigraphy.

Application of stratigraphy was by William Smith in the 1790s and early 1800s. Smith, known as the "Father of English geology".

Created the first geologic map of England and first recognized the significance of strata or rock layering and the importance of fossil markers for correlating strata.

1) **Lithostratigraphy:**

Lithostratigraphy, or lithologic stratigraphy, provides the most obvious visible layering. It deals with the physical contrasts in lithology, or rock type. Such layers can occur both vertically– in layering or bedding of varying rock types.

Lithology:

The **lithology** of a rock unit is a description of its physical characteristics visible at outcrop, in hand or core samples or with low magnification microscopy, such as color, texture, grain size, or composition.

2) **Biostratigraphy:**

Biostratigraphy is the branch of stratigraphy which focuses on correlating and assigning relative ages of rock strata by using the fossil assemblages contained within them.

Biologic stratigraphy was based on William Smith's principle of faunal succession, which predated, and was one of the first and most powerful lines of evidence for, biological evolution.

Out crop:

- An **outcrop** or **rocky outcrop** is a visible exposure of bedrock or ancient superficial deposits on the surface of the Earth.
- Outcrops do not cover everywhere on the surface of the earth, these are mostly covered with a thick and thin layer called alluvium or most common language as soil.
- However, in places where the overlying cover is removed through erosion or tectonic uplift, the rock may be exposed, or *crop out*.

- In fact in some areas the soil may spread over for thousands of square km and the bed block may not be visible anywhere.
- As in the mountains and sub- mountains tracts, exposure of rocks may be easily seen forming sides of valley or caps of hills.
- Hence outcrop is simply defined as “An exposure of solid rock on the surface of the rock”.

Strike :

- Strike is a geographic direction given by the line of intersection of a horizontal plane with a bedding plane of a layer of rock.
- It is measured in field with the help of a compass.

Dip:

- It is defined as the max angle of inclination with the horizontal. It is expressed both in terms of degree of inclination and direction of inclination.
- The amount of dip is called angle of inclination, which a bedding plane makes with a horizontal plane.

True Dip:

- when the dip of the layer is measured in a direction that is essentially at right angles to the strike of the particular layer, then It is called TRUE DIP.

Apparent Dip:

- When the dip of the layer is measured in any other direction which is not a right angles to the strike direction is called APPARENT DIP.

actually measured directly by a clinometer. (16)

→ S-Ray clinometer Compass and the Brunton Compass are some of the more developed and useful versions.

→ The strike direction is expressed in two ways i.e., with reference to north and south.

* FOLDS :

→ When set of horizontal layers are subjected to compressive forces, they bend either upwards or downwards. The bends noticed in rocks are called folds.

→ They are also called flexures or buckling phenomenon of rocks.

* Parts of folds :

Limbs or Flanks - These are the sides of fold. There are two limbs for every fold and one limb common to adjacent folds.

Crest and Trough - The curved portions of the fold at the top and bottom are called crest and trough.

Axial Plane - This is an imaginary line which divides the fold into two equal halves. It passes through either the crest or trough i.e., in between limbs. Depending upon the nature of fold, axial plane may be vertical, horizontal or inclined.

Axis - This is trace of intersection between axial plane and crest of the fold.

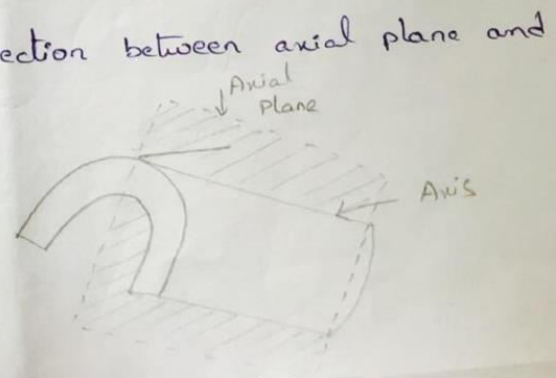
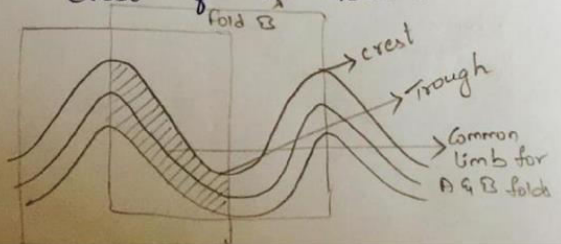

Structural Geology

Indian stratigraphy : kind of study of the earth's history through sedimentary rocks is called historical geology, it is also called as stratigraphy (strata = set of sedimentary, graphy = description) because this subject deals with details & description of sedimentary rock sequences.

Paleontology - under favourable conditions, animals or plant life gets embedded in sediments, it will be preserved partly or completely such relics & remnants of ancient life preserved in rocks by natural process are known as "fossils". Details of mode of formation of fossils, their types, occurrence etc form the subject matter of Paleontology.

out crop - formation which is exposed on the surface is called outcrop. (folds, faults, joints etc).

→ shape & width of outcrop of the inclined bed depends upon the direction & amount of its dip

Faults - Faults may be described as fracture along which relative displacement of adjacent blocks has taken place.

Joints - If such relative displacement does not take place on either side of fracture plane it is called joint.

Parts of faults :- Fault Plane - this is a fracture surface on either side of which rocks had moved past one another.

Foot wall and Hanging wall - Faulted block which lies below the fault plane is called "foot wall" & other block which rests above the fault plane is called "hanging wall".

slip → The displacement that occurs during faulting is called slip.

Heave & Throw →

The horizontal component of displacement is called "heave" & vertical component of displacement is called "throw".

* Classifications & Types of Fault

* Faults are divisible into 1 (Type of displacement along fault plane)

Translational faults, type of displacement of foot wall with reference to the hanging wall is uniform along the fault plane.

Rotational faults - Displacement varies from place to place, the displacement gradually increases & decreases.

2. Relative Movement of Foot wall & Hanging wall

if the hanging wall goes down with reference to the foot wall / is called normal fault or gravity fault

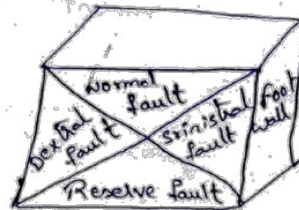

3. Type of slip involved

slip has been already described as the displacement along the fault plane.

If displacement is completely along the dip direction of the fault plane, it is called dip slip fault.

If displacement occur partly along the strike direction and partly along the dip direction of the fault plane then it is called oblique slip fault.

4. High Angle faults and low angle faults

(3)

If the steep is more than 45° , the fault is called a high angle fault and if it is gently sloping i.e., less than 45° the fault is called low angle fault.

* Mode of occurrence

1. Radial faults: when a set of faults occurs on the surface and appear to be radiating from a common point, they are called radial faults.
2. En echelon faults: Refers to a series of minor faults which appear to be overlapping one another.
3. Arcuate or Peripheral faults: These also refer to a set of relatively minor faults which have curved outcrops and are arranged in peripheral manner.

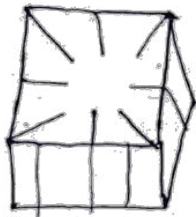

Radial faults

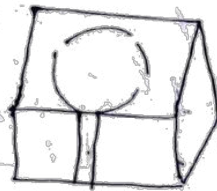

Arcuate faults

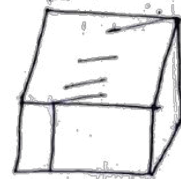

En echelon faults

* Causes of faulting

1. Tensional faults: Faults are formed under the influence of horizontal tensional forces, due to which rock masses would fail along vertical or along steeply inclined planes. Such faults are called Tensional faults.
2. Gravity faults: Faults develop mainly due to shear & sliding failures resulting from tensional, compressional or rotational forces under high angle and low angle faults one set of common type of faults i.e., gravity faults.

3. Thrust faults : These are formed due to compressive forces ^(U) which throw the rocks into folds.

4. Compressional faults : The folded rocks may later get fractured and faulted under shear, these thrust faults may be called Compressional faults.

* Effects of Faulting

1. slickensides : The pieces of rocks which have the foregoing characters i.e., plain surfaces bearing parallel line-like markings with or without polishing are called slickensides
 → when erosion takes place such slickensides appear scattered near and around the fault plane. Thus, their occurrence in the field suggests the occurrence of fault nearby

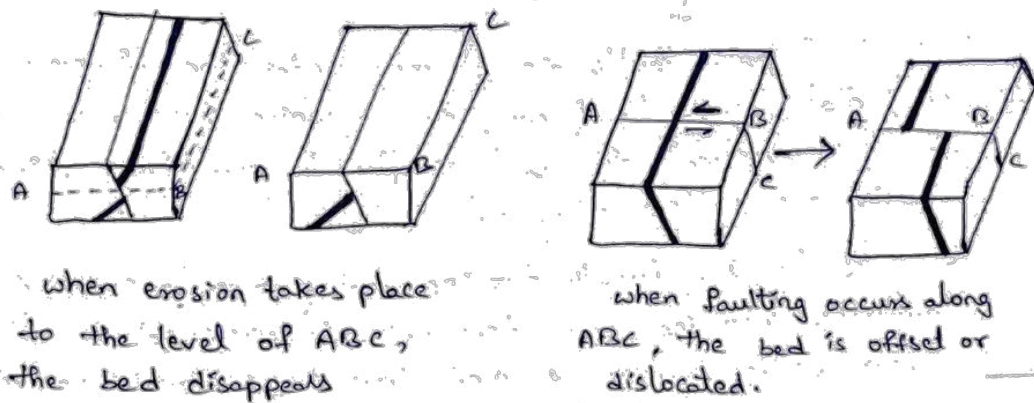
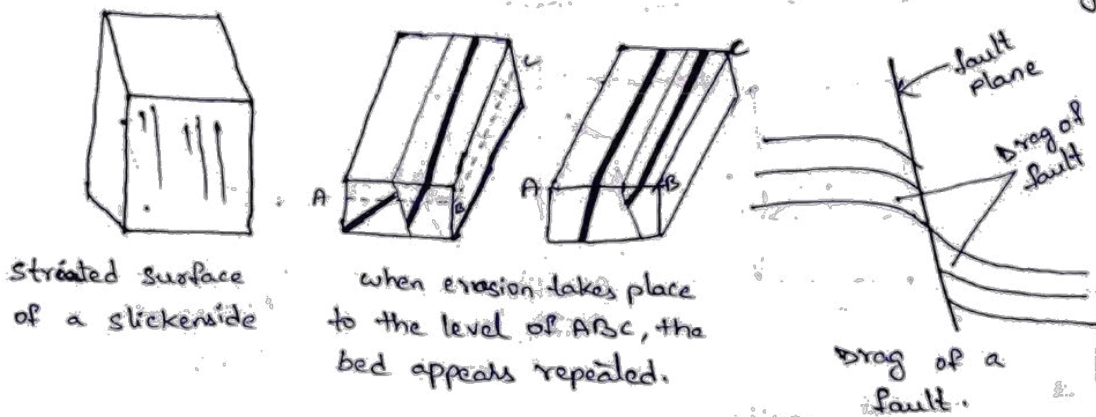

* Classification of joints

(7)

Joints are mainly classified on the basis of their relative attitude and origin.

1. Classification Based on Relative Attitude of joints:

→ When joints are parallel to strike direction or dip direction of adjacent beds, they are called strike joints or dip joints.

→ If the strike direction of joints or dip joints is parallel neither to strike nor dip direction of adjacent beds, then such joints are called "oblique joints."

→ If attitude of joints coincides completely with the attitude of adjacent beds, they are called "bedding joints."

2. Classification Based on origin of joints:

→ Joints are formed due to either tensional or shearing forces. Accordingly they are described as tension joints or shear joints.

→ Columnar joints occur in basalts are typical examples of tension joints. (Primary structures of volcanic igneous rocks)

→ Mud cracks formed due to tensional forces. These are developed due to shrinkage in volume of mud which, in turn was due to escape of enclosed moisture content on evaporation.

→ Shear joints develop in those contexts where shearing forces prevail. Faults & limbs of folds are places where shearing

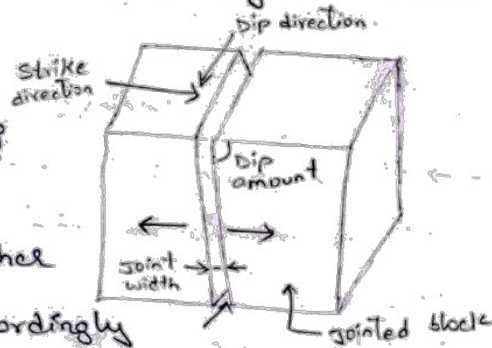

forces occur and create shear joints. (8)

→ Joints are also sometimes described as longitudinal joints & transverse joints depending on whether they are parallel to or across some large-scale features such as mountain ranges in given region.

* Types of joints found in Common Rocks.

→ Granites and other similar rocks are sometimes characterized by the presence of a joint system known as "mural joints". (Mural - cubical block). Mural joints are often accompanied by two other sets of microstructures which are known as "rift and grain".

→ From Civil Engineering point of view, the mural joints facilitate easy quarrying, while rift and grain are helpful in dressing of rocks.

→ The plutonic rocks igneous rocks in general characterized by a set of nearly horizontal joints, which are known as "sheet joints".

→ Plutonic igneous rocks which are formed at great depths will be under stress due to great overburden.

Joints in Sedimentary Rocks:

→ Joints are common in all types of sedimentary rocks and their occurrence depends upon the tectonic history of the concerned region. The folded & faulted sedimentary rocks will be associated with tension & shearing joints.

Joints in Metamorphic Rocks :-

(9)

- Though joints are found very commonly in metamorphic rocks also, they do not have any definite pattern of occurrence in any specific kind of rocks.
- When shear between beds occurs either due to folding or faulting, system of fractures often develops. In the weak beds these fractures are generally closely spaced.
- Because of these fractures, the rock can split into thin sheets. Such a phenomenon is called rock cleavage or fracture cleavage.

* UNCONFORMITY

- When sedimentary rocks are formed continuously or regularly one after another without any major break, they are said to be set of conformable beds, and this phenomenon is called "Conformity".
- If a major break occurs in sedimentation rocks in between two sets of conformable beds, it is called as "unconformity".
- An unconformity which represents a long geological period is known as "hiatus".

Types of Unconformities

1. Non-Conformity: When the underlying older formations are represented by igneous or metamorphic rocks and the overlying younger formations are sedimentary rocks, the unconformity is called "non-conformity".
2. Angular Unconformity: When the younger and older sets of strata are not mutually parallel, then the unconformity is called "angular unconformity".

actually measured directly by a "clinometer". (16)

→ S-Ray clinometer compass and the Brunton compass are some of the more developed and useful versions.

→ The strike direction is expressed in two ways i.e., with reference to north and south.

* FOLDS :

→ When set of horizontal layers are subjected to compressive forces they bend either upward or downwards. The bends noticed in rocks are called folds.

→ They are also called flexures or buckling phenomenon of rock.

* Parts of folds :

Limbs or Flanks - These are the sides of fold. There are two limbs for every fold and one limb common to adjacent folds.

Crest and Trough - The curved portions of the fold at the top and bottom are called crest and trough.

Axial Plane - This is an imaginary line which divides the fold into two equal halves. It passes through either the crest or trough i.e., in between limbs. Depending upon the nature of fold, axial plane may be vertical, horizontal or inclined.

Axis - This is trace of intersection between axial plane and crest of the fold.

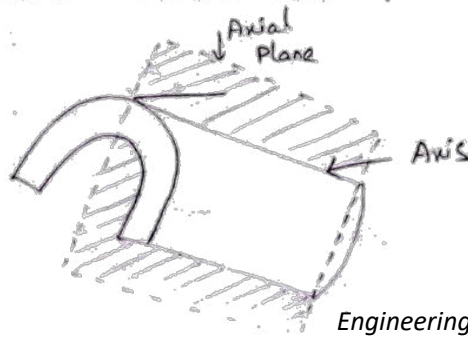
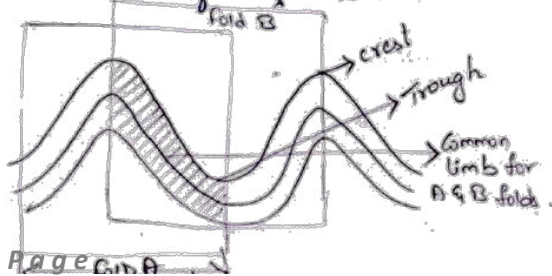

* Types of Folds :

1. Anticline & Syncline - When the beds are bent upwards, the result fold is called anticline. The fold is convex upwards. In such a fold the older beds occur towards Concave side.

Syncline is just opposite to anticline in its nature. This fold is convex downwards, Beds are bent downwards.

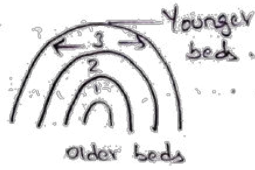

Anticline

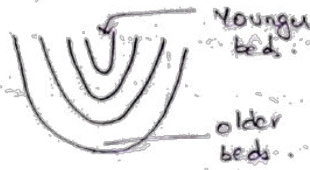

Syncline



Symmetrical anticline
 $A=B$

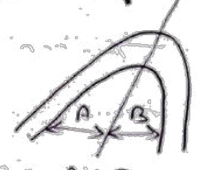

Asymmetrical anticline
 $A \neq B$

2. Symmetrical and Asymmetrical Folds :

→ When axial plane divides a fold into two equal halves in such a way one half is mirror of another half, such fold is called symmetrical fold.

→ If the two halves are not mirror images, then the fold is called asymmetrical fold.

3. Plunging and Non-Plunging Folds :

→ Plunge is described as the angle between the axis and horizontal plane. Whether the axis of fold is inclined or horizontal the folds are grouped as plunging or non-plunging fold.

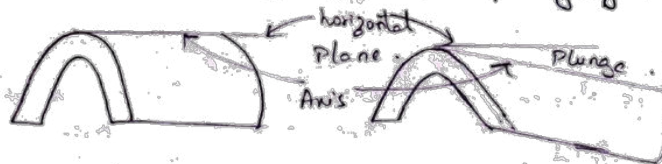

non-plunging anticline

Plunging anticline

4. Open and close folds :

→ If the thickness of beds is uniform through out the fold , it is called an open fold .

→ On the other hand , if the beds are thinner in limb portion & thicker at crest & troughs , such a fold is called a closed fold .

5. Similar and Parallel folds :

→ In similar fold the shape & Pattern of fold remains same at depths ; in case of parallel folds the crest & trough become pointed or angular .

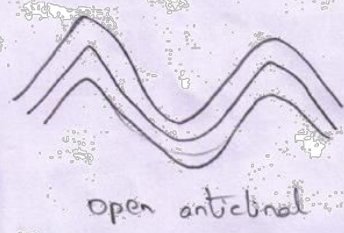

Open anticlinal

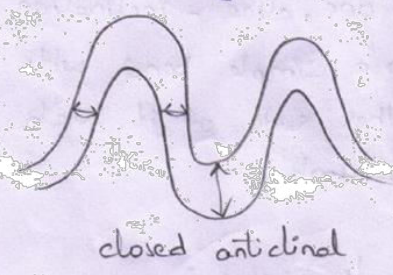

closed anticlinal

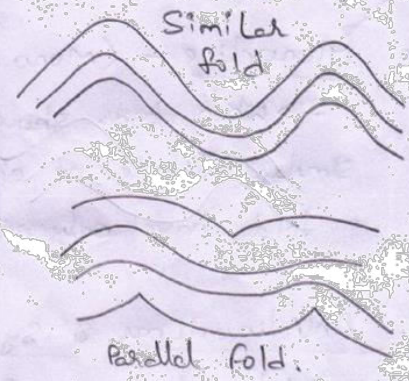

Similar fold

Parallel fold

6. Overturned fold :

→ When one of the limb is overturned , the order of Superposition (younger beds overlie the older beds) of beds in that limb will be in reverse order & such fold is called overturned fold .

7. Chevron folds :

→ The crests & troughs of beds are smoothly curved . But some folds have sharply bent , angular crests & troughs . Such folds are known as "chevron folds" .

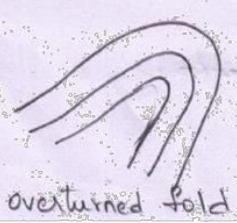

overturned fold



chevron fold

8. Isoclinal folds:

→ Limbs will be mutually diverging or converging with reference to axial planes. In some folds, the limbs will be mutually parallel to a great extent.

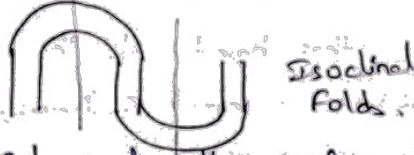

9. Fan folds:

→ The limb dip towards each other reference to their axial plane. In syncline the limb dip away from each other.

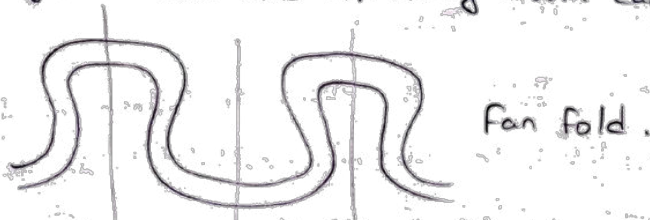

10. Monocline - (Mono - one, cline - inclination)

→ When beds show a simple bend with similar attitude on either side of it, such a fold have only one limb.

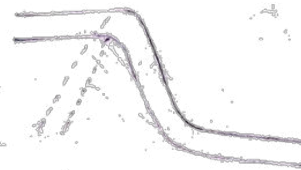

11. Anticlinorium & Synclinorium:

→ When limbs & folds are not plain major folds are called anticlinorium & synclinorium.

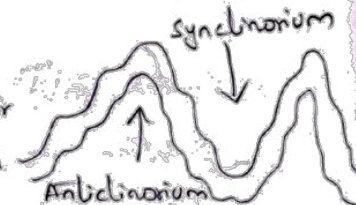

12. Drag folds:

→ Folds within major folds but confined only to incompetent beds which are sandwiched between competent formations.

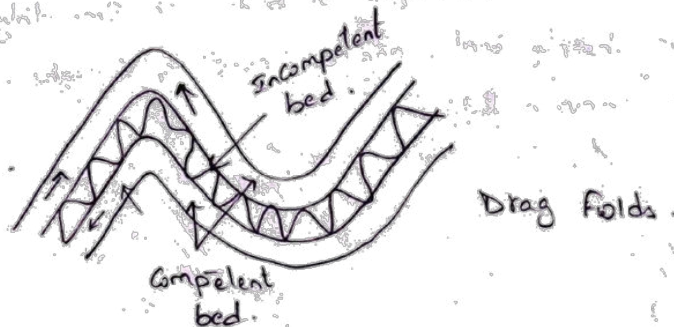

EARTH QUAKES

DEFINITION:

- A sudden violent shaking of the ground, typically causing great destruction, as a result of movements within the earth's crust or volcanic action.
- A sudden release of energy in the earth's crust or upper mantle, usually caused by movement along a fault plane or by volcanic activity and resulting in the generation of seismic waves which can be destructive.

Seismic Waves

- **Seismic waves** are **waves** of energy that travel through the Earth's layers, and are a result of an **earthquake**, explosion, or a volcano that gives out low-frequency acoustic energy.
- Seismic waves are studied by geophysicists called **seismologists**. Seismic wave fields are recorded by a seismometer, hydrophone (in water), or accelerometer.ncy acoustic energy.
- The propagation velocity of the waves depends on density and elasticity of the medium.
- Velocity tends to increase with depth and ranges from approximately 2 to 8 km/s in the Earth's crust, up to 13 km/s in the deep mantle.

CLASSIFICATION AND CAUSES OF EARTHQUAKE:

Based on depth of their origin, earthquake is described as shallow or intermediate or Deep.

- Earthquake with a focus depth less than 60km are called shallow earthquake.
- If the depth more than 60km but less than 300km, they are called Intermediate earthquake.

- Which have focus depth more than 300km, they are called Deep earthquake.

Based on the causes responsible for their occurrence, earthquakes are described as Tectonic or non Tectonic.

- **Tectonic earthquake** are exclusively due to internal causes, due to disturbances or adjustments of geological formations taking place in the earth's interior, they are less frequent, but more intensive and hence more destructive in nature.
- The **Non Tectonic earthquake** on the other hand, is generally due to external or surfacial causes. This type of earthquake is very frequent, but minor in intensity and generally not destructive in nature.

Types:

Among the many types of seismic waves, one can make a broad distinction between *body waves* and *surface waves*.

- Body waves travel through the interior of the Earth.
- Surface waves travel across the surface. Surface waves decay more slowly with distance than do body waves, which travel in three dimensions.

Includes **Primary** and **Secondary** waves:

Primary waves (P-wave):

- Primary waves are compressional waves that are longitudinal in nature. P waves are pressure waves that travel faster than other waves through the earth to arrive at seismograph stations first, hence the name "Primary".
- These waves can travel through any type of material, including fluids, and can travel at nearly twice the speed of S waves. In air, they take the form of sound waves, hence they travel at the speed of sound. Typical speeds are 330 m/s in air, 1450 m/s in water and about 5000 m/s in granite.

Secondary waves(S-Waves):

- Secondary waves (S-waves) are shear waves that are transverse in nature. Following an earthquake event, S-waves arrive at seismograph stations after the faster-moving P-waves.
- S-waves can travel only through solids, as fluids (liquids and gases) do not support shear stresses. S-waves are slower than P-waves, and speeds are typically around 60% of that of P-waves in any given material.

SEISMIC BELTS AND SHIELD AREAS:

- Seismic belts are those places where earthquakes occur frequently. Shield areas are those places where earthquakes occur either rarely or very mildly.
- Occurrence of an earthquake in a place is an indication of underground instability there.
- Statistics have revealed that nearly 50% of earthquakes have occurred along mountain ridges and 40% of earthquakes along steep coasts.
- The study of recorded earthquakes shows that they take place on land most frequently along two well-defined seismic belts.
 1. *Circum Pacific Belt* which accounts for 68% of earthquake occurrence.
 2. *Mediterranean belt* accounts 21% of earthquake which extends east-west from Portugal, Himalayas and Burma with a branch through Tibet and China.

RICHTER SCALE:

- The **Richter magnitude scale** (also **Richter scale**) assigns a magnitude number to quantify the energy released by an earthquake.

- The Richter scale, developed in the 1930s, is a base-10 logarithmic scale, which defines magnitude as the logarithm of the ratio of the amplitude of the seismic waves to an arbitrary, minor amplitude.
- In 1935, the seismologists *Charles Francis Richter* and *Beno Gutenberg*, of the California Institute of Technology, developed the (future) Richter magnitude scale, specifically for measuring earthquakes in a given area of study.
- The Richter scale was succeeded in the 1970s by the Moment Magnitude Scale (MMS). This is now the scale used by the United States Geological Survey to estimate magnitudes for all modern large earthquakes.
- An Earthquake of magnitude 5 may cause damage within radius of 8km, but that of magnitude 7 may cause damage in a radius of 80km, and that of 8 over a radius of 250km.

CONSTRUCTION OF BUILDINGS IN SEISMIC AREAS- PRECAUTIONARY MEASURES:

- Buildings should be Founded on hard bedrock only and never on loose soils or Fractured rocks, this is because lose ground settles due to earthquake vibrations.
- Buildings situated in cuttings on hill slides, near sheet slopes always suffer more when an earthquake occurs.
- For large Buildings, raft types of foundations are desirable. Square foundations are more stable.
- Different parts of a building should be well tied together so that the whole structure behaves like a single unit to the Vibrations.
- Only rich cement mortar and reinforced concrete should be used.
- Buildings with irregular shapes with wings, Verandas, Porches and all structures should be avoided.

- Buildings should have RCC roofs and they should be designed not to yield to lateral stress.
- Resonance is the important factor, If the period of vibration of a structure is the same as that of the foundation rock it will collapse because of the resonance effect.

CIVIL ENGINEERING CONSIDERATIONS IN SEISMIC AREAS:

- Seismic areas are the places which experience earthquakes frequently.
- Therefore constructions in seismic and a seismic areas differ in terms of their design.
- So a civil engineer should only think of making his constructions immune to earthquakes.

It is possible to find the difficulties by predicting some crucial factors:

- I.The exact place of earthquake occurrence.
- II.The duration of the earthquake.
- III.The direction of movement of the ground at the time of earthquake.

BASICS OF A DAM:

In a way ,the success of dam is not only related to its own safety and stability but also depends on the success of associated reservoirs.

If in a dam construction the dam stands firmly and the reservoir leaks , then the dam is to be treated as a failure because the purpose for which it has been constructed has not been served.

Therefore care is needed in construction of dam and reservoir.

The important geological considerations in the selection of dam site are as follows:

The geological considerations are :

1. Narrow river valley
2. Occurrence of bed rock at a shallow depth
3. Competent rocks to offer a stable foundations

BEDROCK AT SHALLOW DEPTH

To ensure the stability and safety of a dam, the dam has to rest on very strong and very stable rocks(i.e bedrock).

If the bedrock is available at shallow depth then the cost for the foundation of dam is less.

If in any case the bedrock is at greater depth then the cost is high as it needs lot of excavation and concrete filling.

Therefore to ensure the bedrock has actually reached bores should be drilled for 20' or more through the rocks.

Competent rocks for safe foundation.

If igneous rocks occur at the site selected for dam, then they will offer a safe foundation.

If sedimentary rocks occur like shale, poorly cemented sandstones and limestone then they shall naturally be undesirable to serve as foundation rocks.

In metamorphic rocks the rocks like marbles, like quartzites can bear a granulose structure and they are not porous and permeable, therefore metamorphic rocks are unsuitable for dam sites.

DAMS AND RESERVOIRS AND THEIR ENVIRONMENTAL IMPACTS

DAMS

- A dam is a barrier that impounds water or underground streams.
- Generate electric power.
- Manage or prevent water flow into specific land regions.
- Evenly distributed between locations.

BENEFITS OF DAMS

1. Power generation
2. Water supply
3. Stabilize water flow / irrigation
4. Flood prevention
5. Land reclamation
6. Recreation and aquatic beauty
7. Navigation

DISADVANTAGES OF DAMS

1. Seepage and evaporation
2. Groundwater table effects
3. Sedimentation behind dams
4. Erosion downstream by sediment-starved waters
5. Clogging of rivers by side-canyon floods

RESERVOIR

The dams constructed across the rivers create artificial lakes which are known as reservoirs.

ENVIRONMENTAL IMPACTS OF DAMS

1. Biological, chemical and physical properties of rivers
2. Blocks fish migrations
3. Traps sediments
4. Changes in temperature, chemical composition, dissolved oxygen levels and the physical properties of a reservoir are often not suitable to the aquatic plants and animals.
5. Reservoirs often host non-native and invasive species (e.g. snails, algae, predatory fish)
6. Species in the area
7. Water quality
8. Fertility of the land
9. Problems of pollution
10. Social impacts
11. Soil Erosion
12. Species Extinction
13. Spread of Disease

CHANGES TO EARTH'S ROTATION

Nasa geophysicist Dr. Benjamin Fong Chao found evidence that large dams cause changes to the earth's rotation, because of the shift of water weight from oceans to reservoirs. Because of the number of dams which have been built, the Earth's daily rotation has apparently sped up by eight-millionths of a second since the 1950s. Chao said it is the first time human activity has been shown to have a measurable effect on the Earth's motion.

EXAMPLES OF GEO HAZARDS

Geo hazard includes :

- Earthquakes
- Landslides
- Tsunamis
- Avalanches
- Floods
- Volcanoes

EARTHQUAKES

Earthquake is a sudden vibration that occurs on the surface of the earth with a release of large amount of energy.

The point of originating of earthquake is known as focus or hypocenter

The point on the earth's surface which lies vertically above the focus is known as epicentre.

Classification of earthquakes

Based on their mode of origin :

Earthquakes occurring due to surface causes due to volcanic causes due to tectonic causes.

Based on depth of focus:

Shallow focus earthquakes(<55km)

Intermediate focus earthquakes(55-300km)

Deep focus earthquakes(300-650km)

CAUSES OF EARTHQUAKES

Earthquakes occur due to:

Tsunamis

Occurrence of

landslides Avalanches

Volcanic eruptions

Man-made

explosions Meteorites

LANDSLIDES

If a mass of earth or rock moves along a definite zone or surface the failure is called as Landslide.

The foremost force responsible for the occurrence of landslide is due to the action of gravity.

CAUSES OF LANDSLIDES



Natural causes

1. Due to ground water pressure
2. Due to melting of glaciers and heavy rainfall
3. Due to volcanic eruptions.



Human causes

1. Due to heavy machinery equipments and traffic flow.
2. Blasting of rocks weakens the stability of slope

TSUNAMI

1. A Tsunami is a giant wave (or series of waves) created by an undersea earthquake, volcanic eruption and landslide.
2. Tsunamis are often called as tidal waves but this is not accurate description because tides have little effect on giant tsunami waves.

VOLCANOES

A Volcano is a vent (hole) in the earth's crust through which lava, steam, ashes and etc., are expelled.

AVALANCHES

1. An Avalanche is any amount of snow sliding down a mountainside.
2. Another term for avalanche is snow slide.

FLOODS

A Flood is an overflow of water that submerges the land which is usually dry.

EFFECTS OF GEOHAZARDS

A great loss of plant, human and animal life.

Destruction and damage to the buildings.

Disruption of civic facilities like electricity, water, telephones.

Loss of communication such as road, rail, water and air transportation.

Increase in infectious diseases due to the pollution created by this hazards.

WATER TIGHTNESS AND INFLUENCING FACTORS

WATER-TIGHTNESS:

It is the process which is implemented after the effect of weathering in order to preventing the leakage of water through fractured rock and bed rocks which are located below the surface and covered with loose soil.

- If the dam is constructed without proper water-tightening, the impounded water in the reservoir covers large area and percolates over it.
- Due to higher level of the water in reservoir, hydrostatic pressure is formed, which makes the leakage of water more effective on sides and floor of the reservoir.

INFLUENCING FACTORS:

- Buried river channels
- Influence of rock type
- Influence of geological structures
- Scope of preventing leakage
- Influence of water table.

GEOLOGICAL FACTORS EFFECTING

WATERTIGHTNESS CONTENTS:

- Water tightness introduction
- Factors affecting water tightness
- Factors affecting life of a reservoir

WATER TIGHTNESS:

Water at the site of reservoir and dam tends to percolate to underground through fractures and voids, this leakage may results in decrease in water level at reservoir so a reservoir must be made with sufficient water tightness.

- Factors effecting water tightness
- Buried river channel
- Types of rocks
- Geological structures
- Water table
- Presence of impermeable of permeable layer on the surface

BURIED RIVER CHANNEL:

This is generally present as a glaciers below the surfaces it may not decrease the water tightness.

ROCK TYPE:

- Generally faults and fractures present in igneous and metamorphic rocks so rock used in construction of reservoir should have less fractures
- Geological structures, water table and some other factors may not have much effect as above.

ELECTRICAL METHODS

INDEX :

- Electro resistivity method.
- Electromagnetic method.
- Self potential method.

ELECTRO RESISTIVITY METHOD:

- The formation of electrical resistivities of sub-surface differ from one another if they are homogenous.
- These resistivities are studied by means of resistivity method.
- They are two types of resistivity investigations

1) Profiling

2) Sounding

ELECTRO MAGNETIC METHOD :

In the principles of electromagnetic field an alternating magnetic field is formed in ground with help of an appropriate source. The formed electromagnetic field induces eddy currents in conductive ore bodies in sub-surface and these produces secondary electromagnetic fields. The magnetic element of secondary electromagnetic field is examined at surface to find underground ore deposits.

Important electromagnetic methods are

- 1) Dip angle method
- 2) Enslin method
- 3) Sling ram method
- 4) Sandburg method.
- 5) Turram method.

SELF POTENTIAL METHOD :

Self potential method is also known as spontaneous polarization method which is based on electrical potentials naturally present in earth. Pyrite , Pyrhoteians sulphideores which indicates spontaneous polarization. Apart from these graphite produces strong SP method.

ADVANTAGES OF ELECTRO RESSISTIVITY METHODS :

- In the exploration of ground water.
- Exploration of petroleum.
- Finding highly conductive bodies such as sulphide ore bodies and graphite.

ADVANTAGES OF ELECTRO MAGNETIC METHOD :

- Finding ore deposits.
- Exploration of soil.
- Ground water studies where overburden is of high resistivity.

GROUND SUBSIDENCE

INTRODUCTION:

- Small scale vertical movements
- Causing substantial economic losses and societal disruption
- Human induced and natural
- Occurring on time-scales of a few decades

SUBSIDENCE AND UPLIFT:

- Subsidence: The lowering of the land surface due to
 - Creation of cavities in solid rock by mining, combustion of coal or dissolution of soluble material
 - The removal of fluids (water or oil) from the pore spaces of unconsolidated or poorly consolidated sediments
- Uplift: changed land conditions due to expansive soils

SUBSIDENCE:

- Underground mining is the most widespread cause of subsidence by direct removal
- Removal causing changes in local or regional groundwater system either by natural or anthropogenic causes

ADVANTAGE SOF SELF POTENTIAL METHOD:

- Exploration of economic mineral deposits.
- Finding areas of corrosion.
- In bore holes of investigation.

DAMS

Dam is a solid barrier constructed at a suitable location across a river valley to store flowing water and used for

- Hydropower
- Irrigation
- Water for domestic consumption
- For drought and flood control
- Other additional utilization is to develop fisheries

TYPES OF DAMS

There are four types of dams. They are

- Arch dam
- Gravity dam
- Buttress dam
- Earth dam

ARCH DAM:

- This type of dams are concrete dams which are curved or convex upstream in plan. It is dependent upon the arch action for its strength.
- Arch dam is thinner and requires less material for construction compared to other dams.
- Arch dams are built across narrow deep river gorges.

GRAVITY DAM

- Gravity dams are the dams which resist the horizontal thrust of water entirely by their own weight
- they use their weight to hold back the water in the reservoir
- Made of earth or rock fill or concrete

BUTTRESS DAM

- Buttress dams are dams in which the face is held up by a series of supports.
- Buttress dams can take many forms – the face may be flat or curved.
- Usually buttress dams are made of concrete and may be reinforced with steel bars.

EARTH DAMS

- Earth dams are trapezoidal in shape
- Earth dams are constructed where the foundation rocks are weak to support
- Earth dams are relatively smaller in height and broad at the base
- They are mainly built with clay, sand and gravel. Hence they are also known as Earth fill dam or Rock fill dam